



413101

## Visible Light Detector with Analog and Digital Outputs

### DESCRIPTION

The 413101 is a low cost 4-pin visible light sensor, with a current output which is directly proportional to the light level. It has a built in optical filter to provide a response which is close to the human eye, or "photopic". It also has a digital output to provide on/off switching, with hysteresis to prevent flicker.

The output current can be converted to a voltage by connecting it in series with a resistor. The dynamic range is determined by the external resistor and power supply (e.g. 10K and 5V gives a range of 0 to over 250 Lux, but can be up to 1000 lux with a 1K resistor). The internal dark current cancellation enables high accuracy over the full temperature range, even at low light levels.

### FEATURES

- Near human eye photopic response
- High IR rejection – integrated optical filter
- Current output highly linear vs light level
- 1uA per lux current output
- External resistor sets linear lux range
- Temperature stable
- Integrated high gain photo-current amplifier
- Dark-current cancellation
- Digital output for on/off switching
- Hysteresis to prevent flicker close to switching threshold

### APPLICATIONS

- Dawn/dusk sensing
- Security lighting
- Night-lights
- LCD backlight control

## 1.0 Basic application & test circuit

**Figure A**

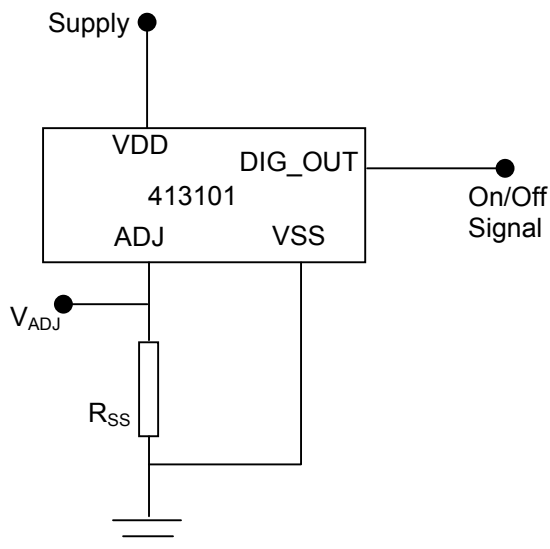

The 413101 is supplied as probed wafers. Failing die are marked with black ink-dots.

#### Pin Description

VDD – Positive supply  
 ADJ – Adjust (analog output)  
 VSS – Ground  
 DIG\_OUT – Digital output (on/off signal)



413101

## Visible Light Detector with Analog and Digital Outputs

### 2.0 FUNCTIONAL DESCRIPTION

Refer to the block diagram Figure B.

Light falling on the 413101 is converted to current by the photodiode PD1. PD2 is also a photodiode but it is covered by a metal layer so that it will not respond to light. At normal temperatures the dark current is very low, however at high temperatures without the dark current cancelling circuit it would become a significant source of error especially at low light levels. The dark current from PD2 is subtracted from the dark current and photo-current of PD1, the resultant current is multiplied by a linear high gain current amplifier and the multiplied current is available as source current from the ADJ pin. The photodiodes are covered by a multi-layer optical filter, which removes the IR light. With this optical filter the 413101 has an approximately "eye like" or photopic spectral response.

The primary function of the 413101 is to convert light to an output current at ADJ pin. The source current from the ADJ pin is proportional to the illumination on the device, at approximately 1uA per Lux. The 413101 has additional circuits to provide a digital ON/OFF output at the DIG\_OUT pin in response to the voltage at the ADJ pin. The current out of the ADJ pin will normally be converted to a voltage by a resistor between ADJ and ground. A 10K resistor would provide a 10mV/lux output voltage at the ADJ pin. The internal resistor chain sets threshold voltages at the inputs of the comparators COMP1 and COMP2. The positive input of COMP1 is set to  $0.15 \cdot V_{DD}$  and the negative input of COMP2 to  $0.1 \cdot V_{DD}$ . When the voltage on the ADJ pin is less than  $0.1 \cdot V_{DD}$  the flip-flop (U1/U2) is set and the DIG\_OUT pin is switched high. When the voltage on the ADJ pin is higher than  $0.15 \cdot V_{DD}$ , the flip-flop is reset and the DIG\_OUT pin is switched low. This "hysteresis" prevents flickering of lamps or chattering of relays when the light level at the sensor is close to the switching threshold.

# Visible Light Detector with Analog and Digital Outputs

**Figure B – Block Diagram**

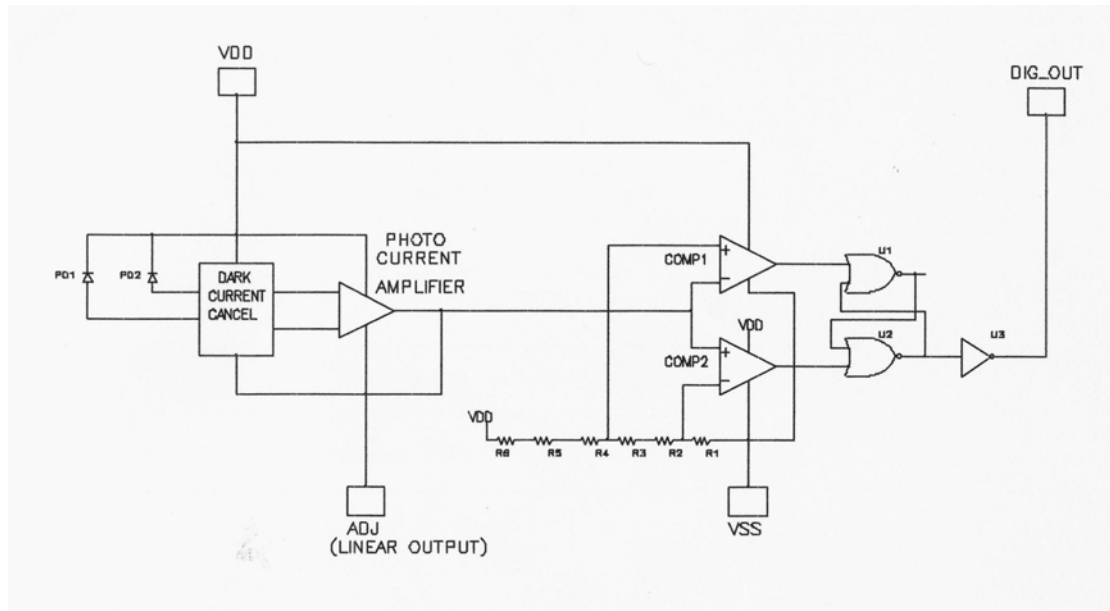

### 3.0 ABSOLUTE MAXIMUM RATINGS

PARAMETER	RATING	UNITS
Supply input voltage	-0.3 to 10	V
Supply current	Internally limited	mA
Operating Temperature, $T_o$	-40C to +85C	°C
Storage Temperature, $T_s$	-40C to +100C	°C



413101

## Visible Light Detector with Analog and Digital Outputs

### 4.0 ELECTRICAL SPECIFICATION

The following parameters apply over the operating temperature range  $-40^{\circ}\text{C}$  to  $+85^{\circ}\text{C}$ , and with  $R_{SS}=10\text{ K-Ohms}$  and  $V_{DD}=5\text{V}$ , as per figure A.

Parameter	Symbol	Test conditions	Min	Typ	Max	Units
Infra Red response		900nm		1	5	% of peak
Minimum operational voltage	$V_{DD}-V_{SS}$	300 Lux, $I_{SS}=300\mu\text{A}$		1.8		V
		50 Lux, $I_{SS}=50\mu\text{A}$		1.3		V
ADJUST current	$I_{ADJ}$	300 Lux		300		$\mu\text{A}$
		100 Lux		100		$\mu\text{A}$
		10 Lux		10		$\mu\text{A}$
ADJUST Dark Current	$I_{ADJ(DARK)}$	0 Lux, $T_a=25^{\circ}\text{C}$		<1		nA
		0 Lux, $T_a=85^{\circ}\text{C}$		170		nA
Gain Linearity			-10		10	%
Peak spectral response				520		nm
Sensitive area				0.054		$\text{mm}^2$
ADJUST threshold voltage for switching of DIG_OUT						
Low to high transition on DIG_OUT	$V_{LH}$	Fading light level		$0.1 \times V_{DD}$		V
High to low transition on DIG_OUT	$V_{HL}$	Increasing light level		$0.15 \times V_{DD}$		V
DIG_OUT source current	$I_{OUT\_SOURCE}$	$V_{DIG\_OUT} = V_{DD} - 0.8\text{V}$		2.4		mA
DIG_OUT sink current	$I_{OUT\_SINK}$	$V_{DIG\_OUT} = 0.8\text{V}$		2.2		mA
Useable light range		$V_{SS}$ & $V_{DD}$ dependant	1		1000	Lux

**Note that with a lower  $R_{SS}$  resistance connected between the ADJ pin and ground, the linear light response range can be greatly increased – up to 1000 Lux. See graph on page 6.**

## 3.1 Characteristic Curves

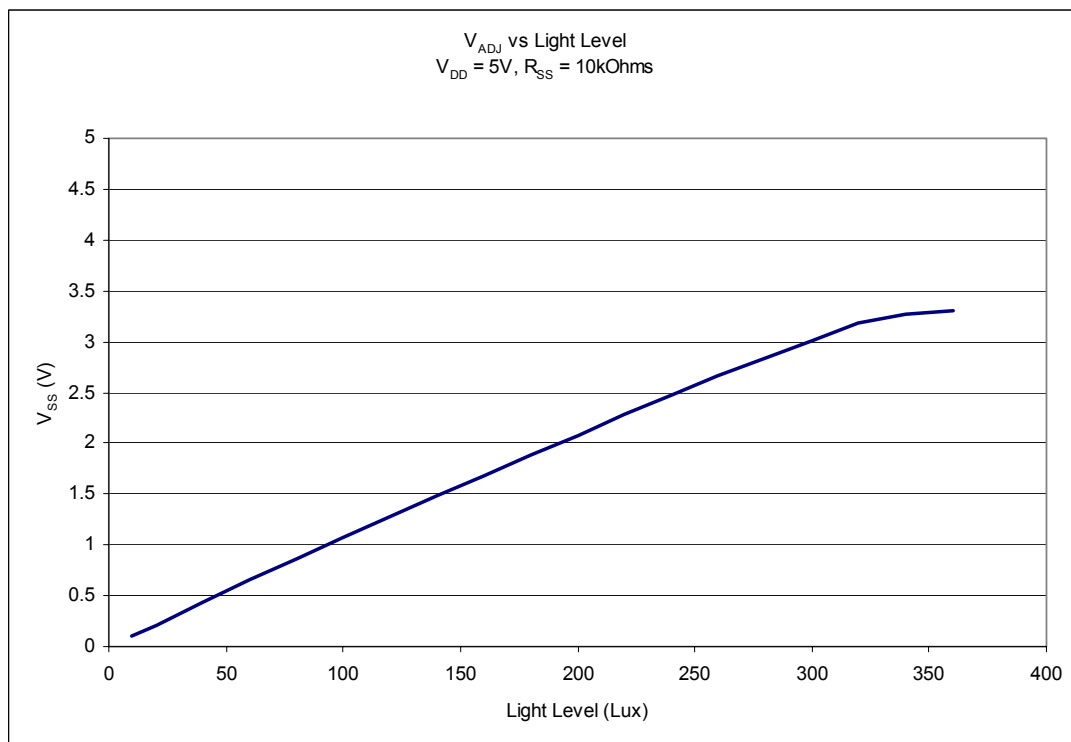
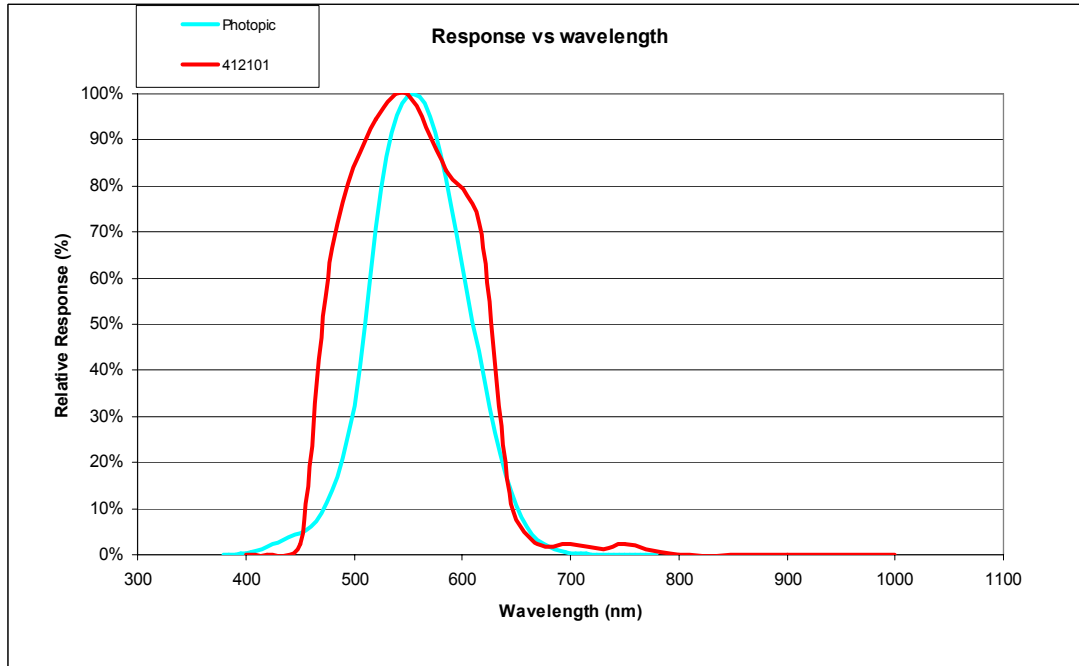

## Visible Light Detector with Analog and Digital Outputs

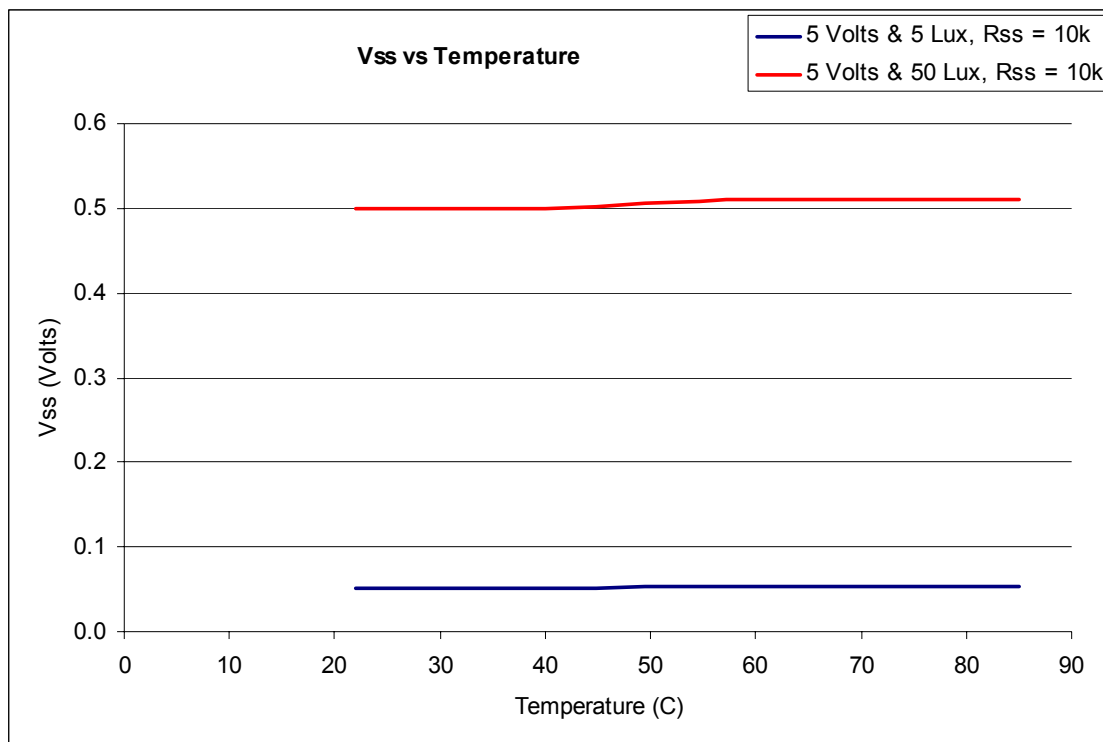
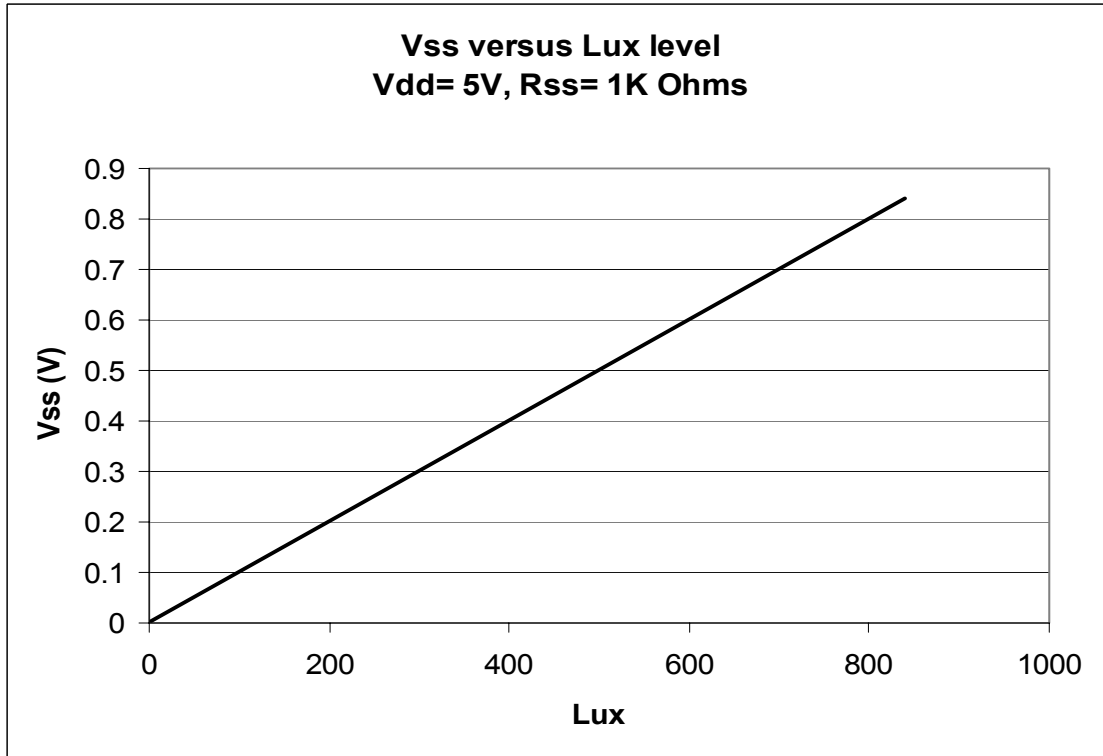



413101

## Visible Light Detector with Analog and Digital Outputs

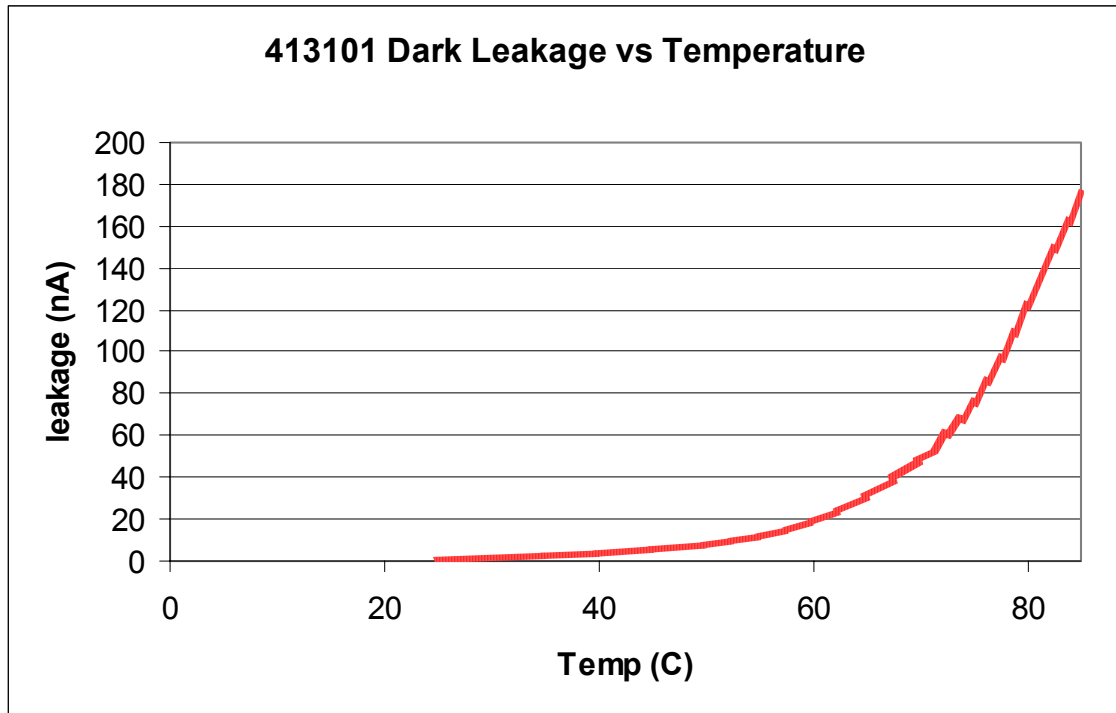

# Visible Light Detector with Analog and Digital Outputs

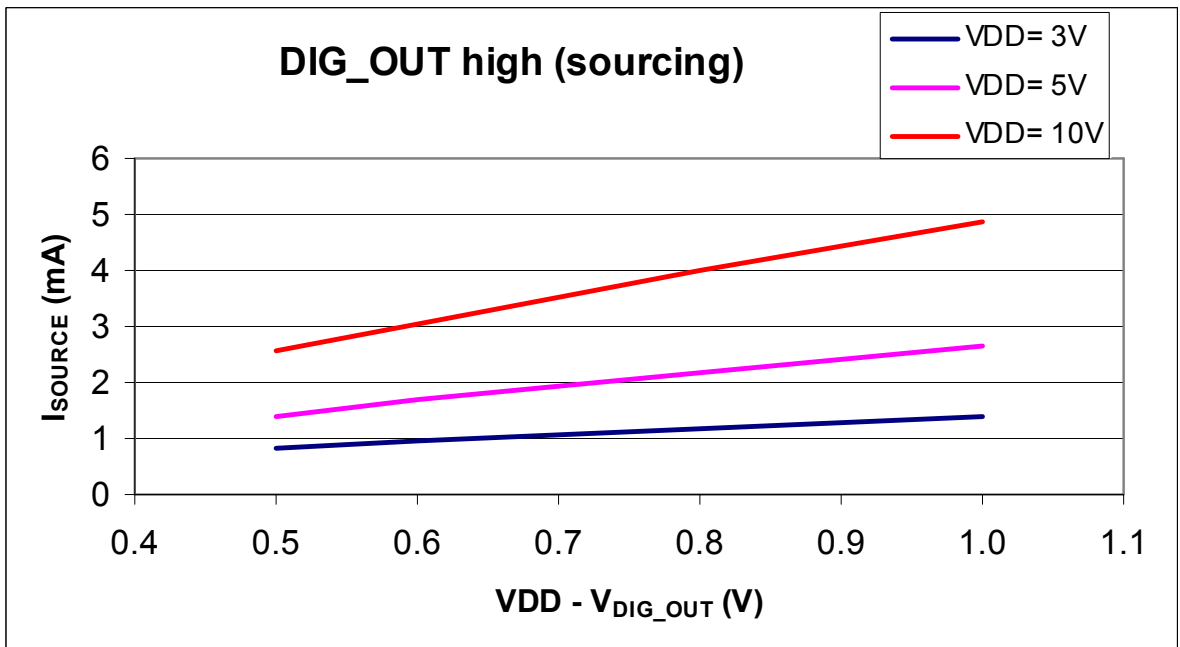
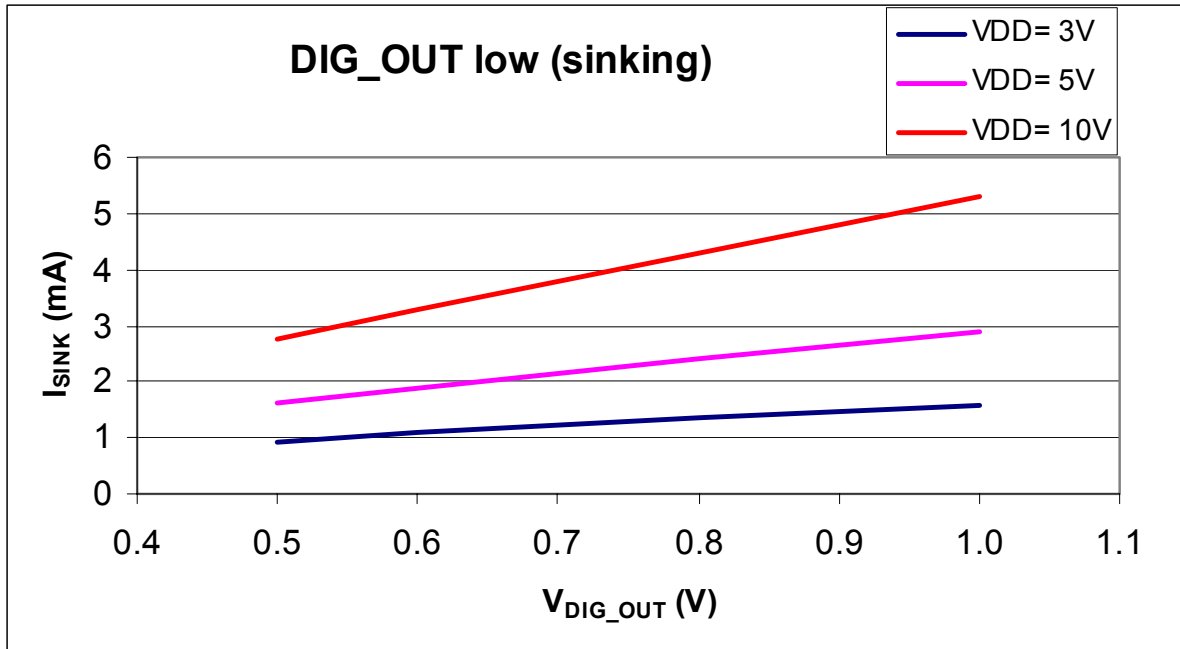





413101

## Visible Light Detector with Analog and Digital Outputs

### 4.0 Application Examples

Note : If the 413101 package has a lens in front of the chip then this will affect the photo sensitivity. The photo sensitivity will also be affected by factors relating to the location of the 413101 in the finished product plastic housings. In some applications the device may sit behind a domed lens which is part of the plastic housing. This lens will increase the photo current and may require a change to the resistor  $R_{SS}$  which set the photo sensitivity or switching point. The resistors suggested in the application circuit examples assume that there is no lens on the package and no lens on the housing.

#### Automatic Night Light

The circuit in FIG1 shows how the 413101 can be used in a Night Light. The power supply to the ASIC is approximately 5VDC. The DIG\_OUT pin will be high when the light on the sensor is less than the lower threshold  $V_{LH}$ . The DIG\_OUT pin will be low when the light on the sensor is higher than the upper threshold  $V_{HL}$ .

At the lower threshold  $V_{LH}$  :  $I_{ADJ} * R1 = 0.1 * V_{DD}$  (1)

At the upper threshold  $V_{HL}$  :  $I_{ADJ} * R1 = 0.15 * V_{DD}$  (2)

The output source current from the ADJ pin ( $I_{ADJ}$ ) is approximately 1uA/Lux.

Example.

$V_{DD} = 5V$ . The light is required to switch ON when illumination at sensor < 20Lux, and switch OFF when illumination at sensor > 30 Lux

With 20 Lux illumination on the sensor  $I_{ADJ} = 20\mu A$ ,

Using formula (1) above,  $R1 = 25K$ .

$R3$  limits the current flow to the gate of the SCR. This circuit should be suitable for logic SCRs however the gate current should not be too high or it will hold down the  $V_{DD}$  supply.

#### LED Drivers

FIG2A shows how the 413101 can be used to drive an LED. The output of the ASIC switches high and the LED is switched ON when the light level on the sensor generates a voltage on ADJ pin <  $V_{LH}$ .  $R2$  limits the base current into TR1.  $R3$  sets the LED current according to the supply voltage. In this circuit, TR1 can be a low cost switching transistor because the 413101 output is a logic signal. The switching thresholds  $V_{LH}$  and  $V_{HL}$  are controlled by  $R1$ .

At the lower threshold  $V_{LH}$  :  $I_{ADJ} * R1 = 0.1 * V_{DD}$

At the upper threshold  $V_{HL}$  :  $I_{ADJ} * R1 = 0.15 * V_{DD}$

It is assumed in the following example that  $I_{ADJ} = 1\mu A/lux$ . This will vary depending on the location and the use of lenses etc.

Example :-

$V_{DD} = 5V$ . The lower threshold will be 30 lux, and the upper threshold will be 45 lux.

30 Lux will provide 30uA at the ADJ pin.

$0.1 * V_{DD} = 0.5$

$30\mu A * R1 = 0.5$

$R1 = 16.6K$  (nearest standard value = 18K)

FIG 2B . In this circuit the LED will switch ON when light on the sensor is higher than  $V_{HL}$  and switch off when the light on the sensor is lower than  $V_{LH}$ . The PNP transistor TR1 switches ON when the ASIC output is low.



413101

## Visible Light Detector with Analog and Digital Outputs

### Relay Driver

Fig 3A.

The 413101 has a push-pull output (DIG\_OUT) which switches high when the light is below  $V_{LH}$ . DIG\_OUT can source approximately 2mA with a 5V supply. R2 limits the base current into TR1.

The switch ON threshold is calculated from

$$I_{ADJ} * R1 = 0.1 * V_{DD}, \text{ where } I_{ADJ} = 1\mu A/lux$$

The switch off threshold is calculated from

$$I_{ADJ} * R1 = 0.15 * V_{DD}$$

The max value of  $I_{ADJ}$  is limited by R1

Fig 3B

In this circuit the relay coil is energised when the DIG\_OUT pin of 413101 is low. This will happen when the illumination  $> V_{HL}$

### Interface Circuit Examples

Fig 4A shows a possible interface to a microprocessor circuit. The analogue output from the ADJ pin is connected to an A/D input port of the micro. The voltage across R1 will vary linearly with the light level. Without a lens, the source current from the ADJ pin is approximately 1uA/Lux so if R1 = 10K, the voltage at the A/D input will vary at 10mv/lux. The analogue port of the micro can then be programmed to read the light level at the sensor. The digital output from the ASIC is connected to a digital input port of the micro, which would allow the port to sense when the light changes between the upper and lower switching thresholds. Typical applications with a microprocessor input could be to control the backlight for the display of a laptop computer or mobile phone.

Fig 4B.

The 413101 has a push- pull CMOS digital output which allows it to interface directly to CMOS logic. The OUT pin is high when the voltage at ADJ  $< 0.1 * V_{DD}$ . The OUT pin is low when the voltage at ADJ is  $> 0.15V_{DD}$ .

# Visible Light Detector with Analog and Digital Outputs

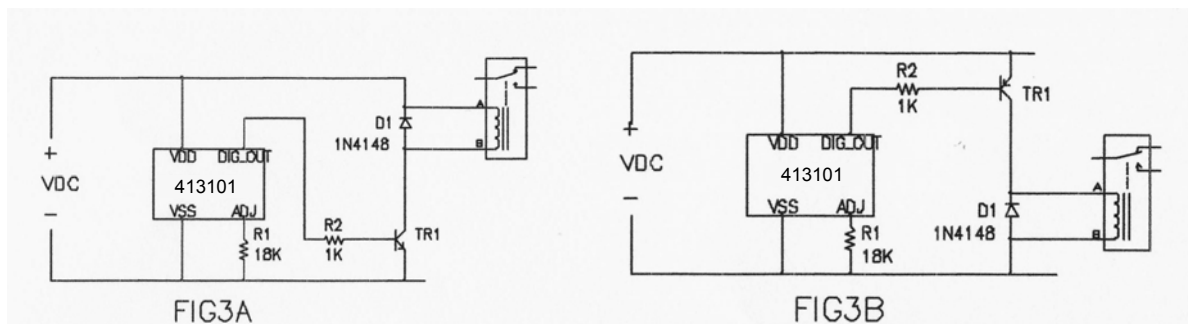
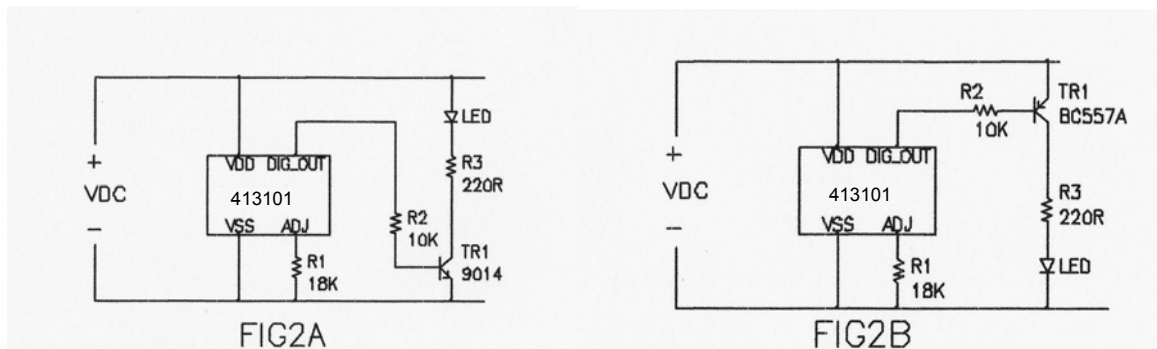
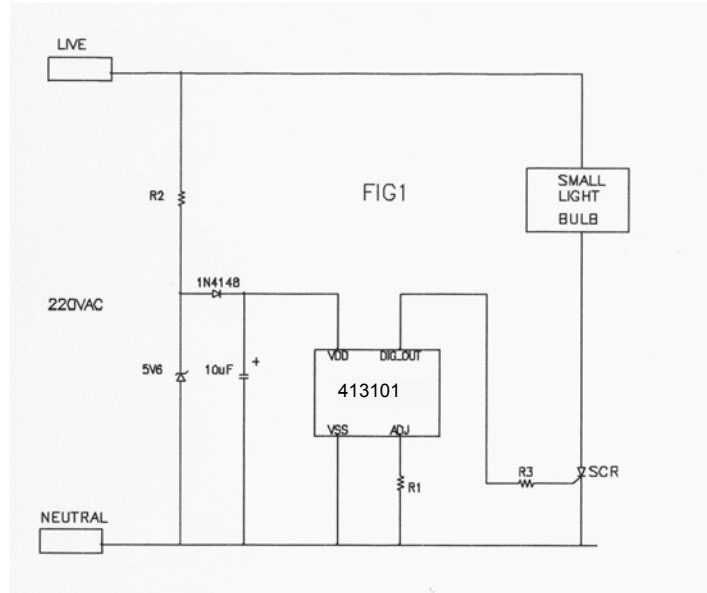

## Visible Light Detector with Analog and Digital Outputs

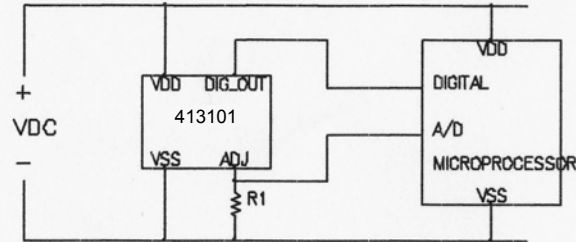

FIG4A

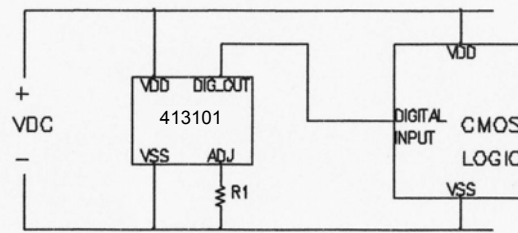

FIG4B